

带座外球面球轴承

UCP2立式带座外球面向心球轴承组件

带止动螺钉-UC210-114D1+UCP210-114D1+P210D1Z(ZM)-UCP210-114D1C(CM)-UCP210-114D1

参数信息:

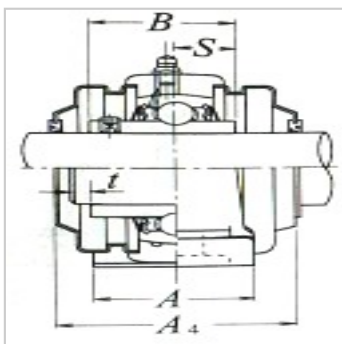
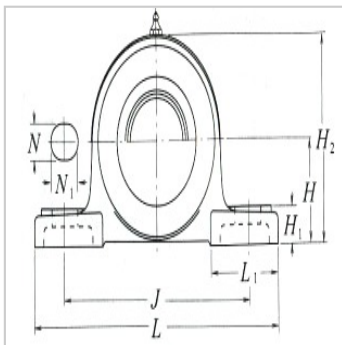
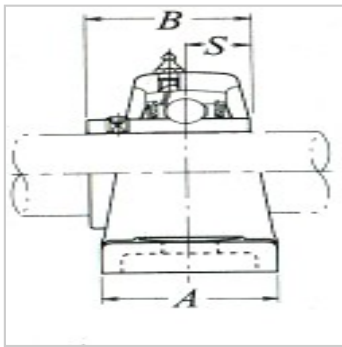
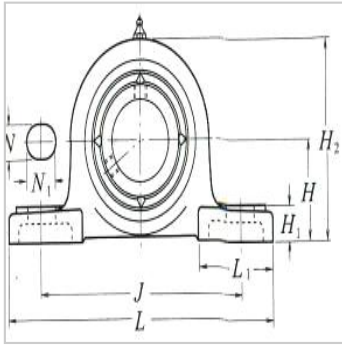

轴径inch :	1 7/8
座组件轴承型号(1) :	UCP210-114 D1

尺寸inch :	
H :	2 1/4
L :	8 1/8
J :	6 1/4
A :	2 3/8
N :	25/32
N :	29/32
H :	13/16
H :	4 1/2
L :	2 9/16
B :	2.0315
S :	0.748

安装螺栓规格inch :	5/8
--------------	-----

轴承代号 :	UC210-11 4D1
--------	--------------

座外型号 :	P210D1
--------	--------

带钢板外罩座组件轴承型号 :	Z(ZM)-UCP210-11 4D1
----------------	---------------------

带铸铁外罩座组件轴承型号 :	C(CM)-UCP210-11 4D1
----------------	---------------------

尺寸inch :	
t(最大) :	1/8
A :	3
H :	4 11/16
A :	3 15/16

带座轴承重量lb :

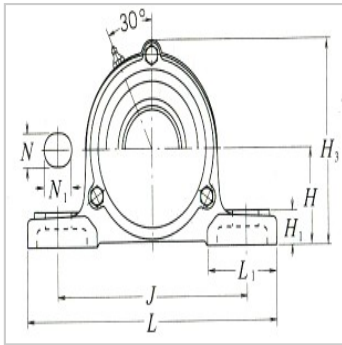

UCP :	5.7
Z(ZM) :	6.2
C(CM) :	9.5

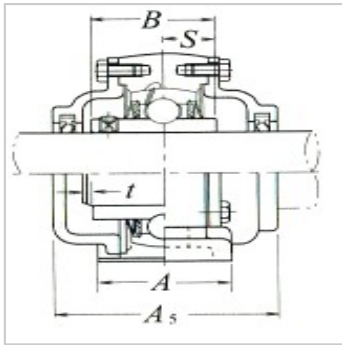

: